



INSTALLATIONSANVISNING

Club 34F

Club 44F

Club 54F

Club 64FSL

Club 644F

Club 864F

Club 964M

Club 64

Club 64SQ

Club 194T

Club 64CSQ

Club 64C

Club 64CTP

Club 34F

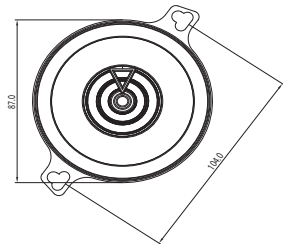
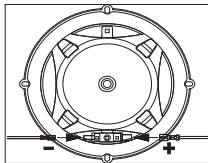
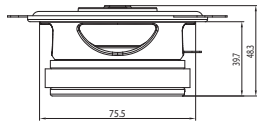

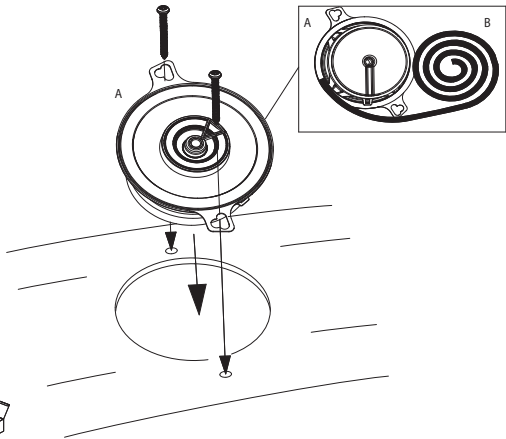
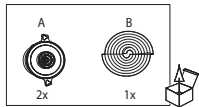

Specifikationer

- Typ: 3,5-tums (87mm) tvåvägshögtalare för bil
- Effekt: 25 W RMS (75 W topp)
- Känslighet (vid 2,83 V/m): 89 dB
- Frekvensåtergivning: 90 Hz – 20 kHz
- Nominell impedans: 3,0 ohm

Thiele-Små Parametrar

- BL (Tm): 2,873
- DCR (ohms): 2,26
- Mms (g): 3,723
- Sd (cm²): 44,18
- Cms (μm/N): 0,491
- Vas (l): 1,3574
- Fs (Hz): 117,7
- Qes: 0,755
- Qms: 7,777
- Qts: 0,688
- Crossover Point: 4kHz

Club 44F

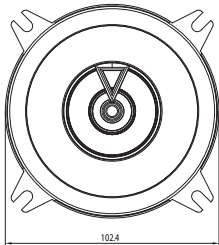
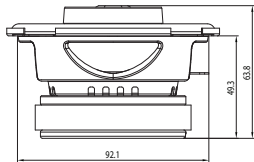
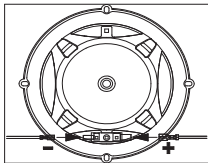

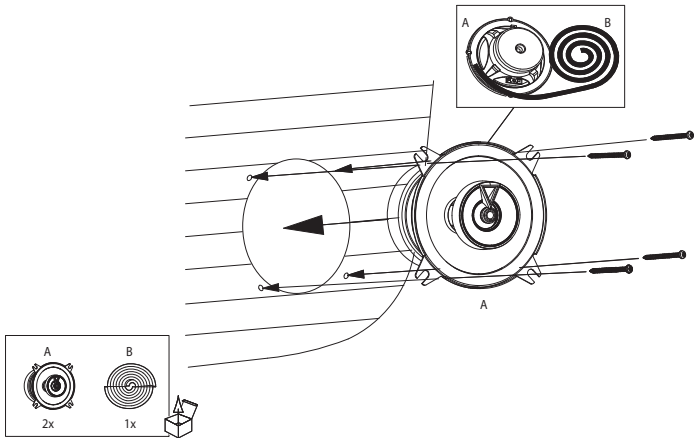

Specifikationer

- Typ: 4-tums (100 mm) tvåvägshögtalare för bil
- Effekt: 35 W RMS (105 W topp)
- Känslighet (vid 2,83 V/m): 90 dB
- Frekvensåtergivning: 75 Hz – 20 kHz
- Nominell impedans: 3,0 ohm

Thiele-Små Parametrar

- BL (Tm): 3,783
- DCR (ohms): 2,46
- Mms (g): 6,608
- Sd (cm²): 63,62
- Cms (μm/N): 0,750
- Vas (l): 4,2937
- Fs (Hz): 71,5
- Qes: 0,510
- Qms: 6,495
- Qts: 0,473
- Crossover Point: 3kHz

Club 54F

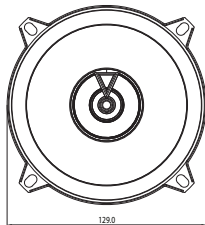
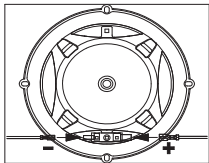
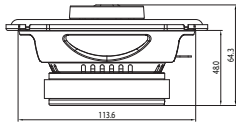

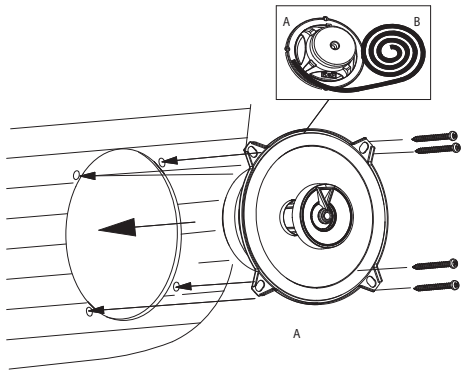
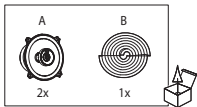

Specifikationer

- Typ: 5,25-tums (130mm) tvåvägshögtalare för bil
- Effekt: 45 W RMS (135 W topp)
- Känslighet (vid 2,83 V/m): 91 dB
- Frekvensåtergivning: 75 Hz – 20 kHz
- Nominell impedans: 3,0 ohm

Thiele-Små Parametrar

- BL (Tm): 3,563
- DCR (ohms): 2,24
- Mms (g): 9,484
- Sd (cm²): 103,87
- Cms (μm/N): 0,274
- Vas (l): 4,1850
- Fs (Hz): 98,7
- Qes: 1,036
- Qms: 8,608
- Qts: 0,925
- Crossover Point: 3kHz

Club 64FSL

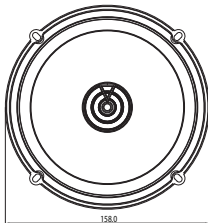
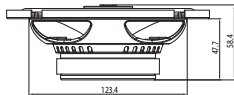
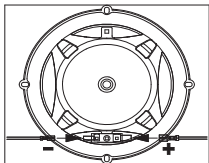

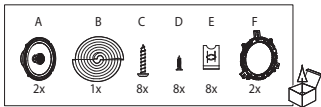
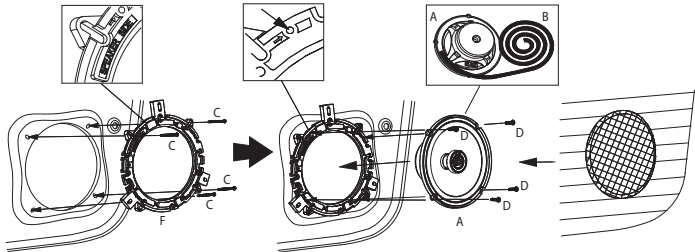

Specifikationer

- Typ: Grundmonterad 6,5-tums (160 mm) tvåvägshögtalare för bil
- Effekt: 55 W RMS (165 W topp)
- Känslighet (vid 2,83 V/m): 92 dB
- Frekvensåtergivning: 55 Hz – 20 kHz
- Nominell impedans: 3,0 ohm

Thiele-Små Parametrar

- BL (Tm): 3,739
- DCR (ohms): 2,41
- Mms (g): 9,934
- Sd (cm²): 122,72
- Cms (μm/N): 0,278
- Vas (l): 5,9287
- Fs (Hz): 95,7
- Qes: 1,032
- Qms: 11,357
- Qts: 0,946
- Crossover Point: 4kHz

Club 644F

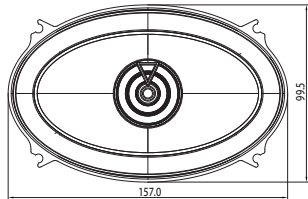
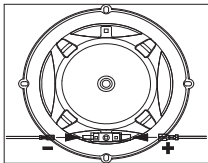
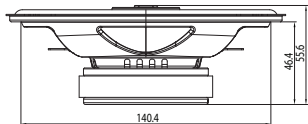

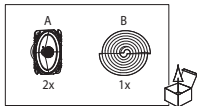
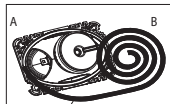
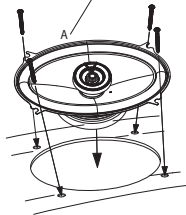
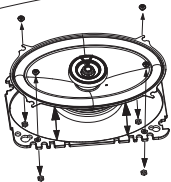
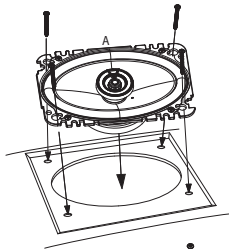

Specifikationer

- Typ: 4x6-tums (100x152 mm) tvåvägshögtalare för bil
- Effekt: 40 W RMS (120 W topp)
- Känslighet (vid 2,83 V/m): 92 dB
- Frekvensåtergivning: 75 Hz – 20 kHz
- Nominell impedans: 3,0 ohm

Thiele-Små Parametrar

- BL (Tm): 3,296
- DCR (ohms): 2,5
- Mms (g): 7,86
- Sd (cm²): 86,59
- Cms (µm/N): 0,245
- Vas (l): 2,5977
- Fs (Hz): 114,7
- Qes: 1,303
- Qms: 12,752
- Qts: 1,182
- Crossover Point: 3kHz

Club 864F

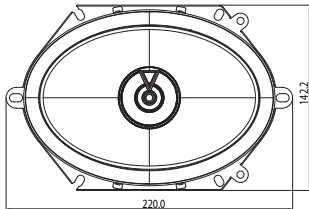
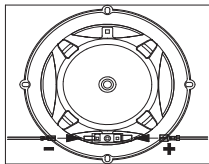
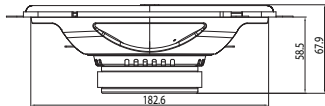

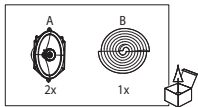
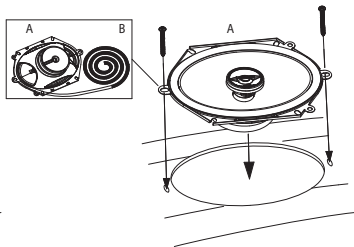
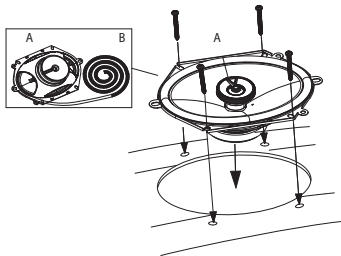

Specifikationer

- Typ: 6x8-tums (152x203 mm) tvåvägshögtalare för bil, utan grill
- Effekt: 60 W RMS (180 W topp)
- Känslighet (vid 2,83 V/m): 93 dB
- Frekvensåtergivning: 65 Hz – 20 kHz
- Nominell impedans: 3,0 ohm

Thiele-Små Parametrar

- BL (Tm): 3,785
- DCR (ohms): 2,39
- Mms (g): 17,718
- Sd (cm²): 165,13
- Cms (µm/N): 0,336
- Vas (l): 12,9798
- Fs (Hz): 65,2
- Qes: 1,210
- Qms: 14,592
- Qts: 1,118
- Crossover Point: 3,5kHz

Club 964M

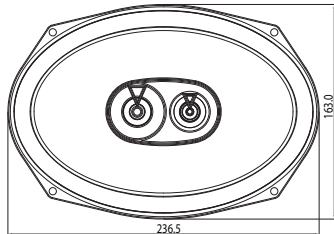
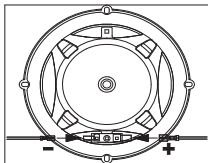
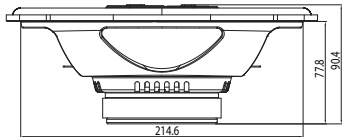

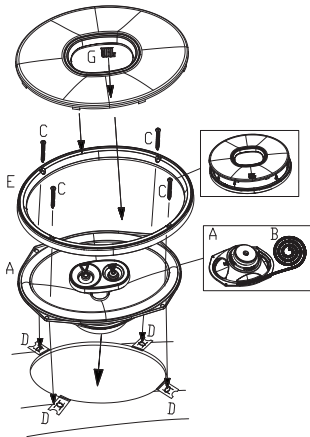
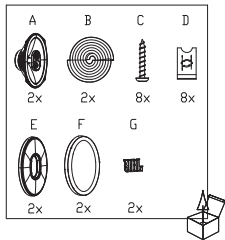

Specifikationer

- Typ: 6x9-tums (152x230 mm) trevägshögtalare för bil
- Effekt: 85 W RMS (255 W topp)
- Känslighet (vid 2,83 V/m): 93 dB
- Frekvensåtergivning: 50 Hz – 20 kHz
- Nominell impedans: 3,0 ohm

Thiele-Små Parametrar

- BL (Tm): 4,063
- DCR (ohms): 2,63
- Mms (g): 23,163
- Sd (cm²): 226,98
- Cms (μm/N): 0,337
- Vas (l): 24,5866
- Fs (Hz): 56,9
- Qes: 1,321
- Qms: 11,751
- Qts: 1,188
- Crossover Point: 3kHz

Club 64

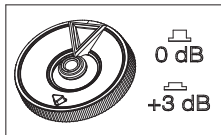
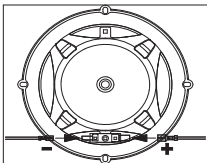

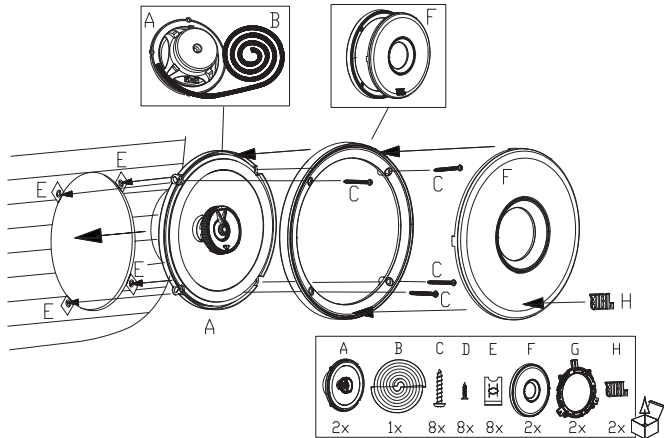

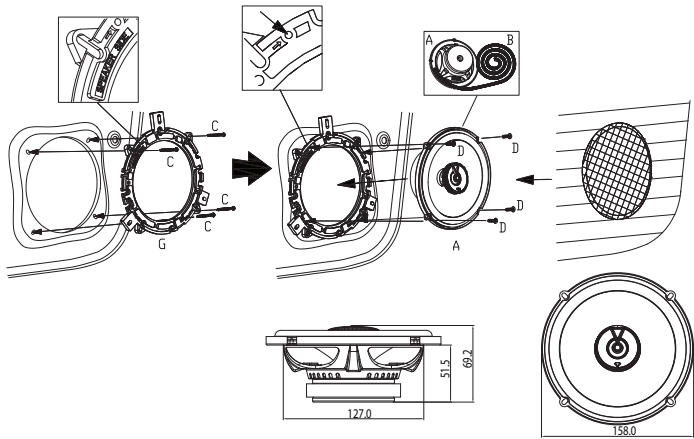

Specifikationer

- Typ: 6,5-tums (160 mm) tvåvägshögtalare för bil. Utvecklad för bättre ljudprestanda.
- Effekt: 60 W RMS (180 W topp)
- Känslighet (vid 2,83 V/m): 93 dB
- Frekvensåtergivning: 48 Hz – 21 kHz
- Nominell impedans: 3,0 ohm

Thiele-Små Parametrar

- BL (Tm): 3,632
- DCR (ohms): 2,36
- Mms (g): 13,758
- Sd (cm²): 132,73
- Cms (µm/N): 0,378
- Vas (l): 9,4253
- Fs (Hz): 69,8
- Qes: 1,080
- Qms: 10,655
- Qts: 0,980
- Crossover Point: 3,5kHz

Club 64SQ

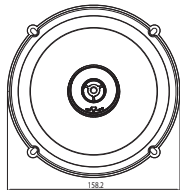
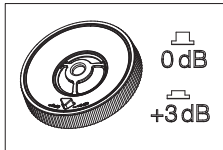
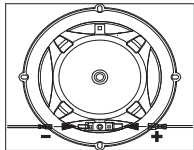
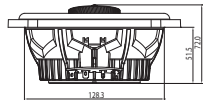

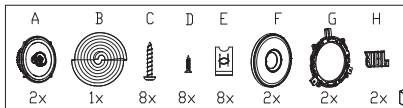
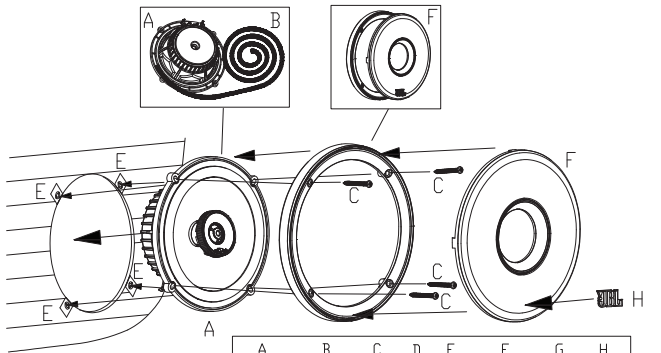

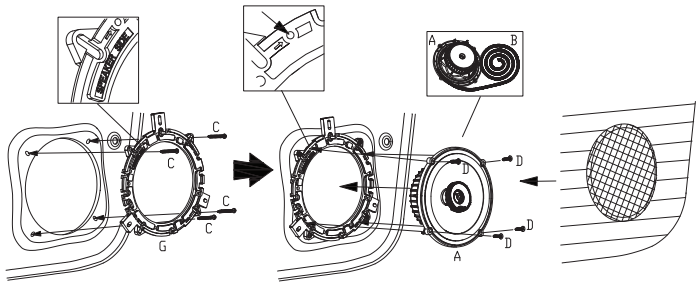

Specifikationer

- Typ: 6,5-tums (160 mm) 2-vägs bilhögtalare, konstruerad för ultimät ljudkvalitet.
- Effekt: 75 W RMS (225 W topp)
- Känslighet (vid 2,83 V/m): 93 dB
- Frekvensåtergivning: 48 Hz – 21 kHz
- Nominell impedans: 3,0 ohm

Thiele-Små Parametrar

- BL (Tm): 3,748
- DCR (ohms): 2,12
- Mms (g): 12,273
- Sd (cm²): 132,73
- Cms (µm/N): 0,530
- Vas (l): 13,2162
- Fs (Hz): 62,4
- Qes: 0,724
- Qms: 9,037
- Qts: 0,671
- Crossover Point: 5 kHz

Club 194T

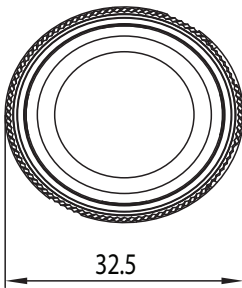
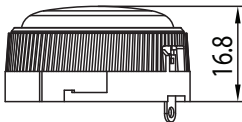

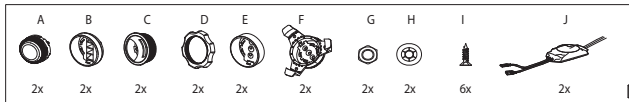
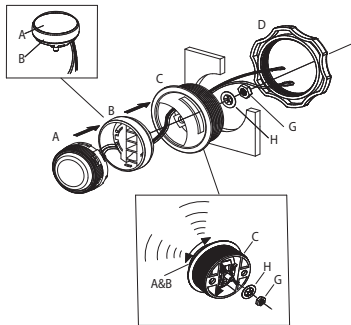
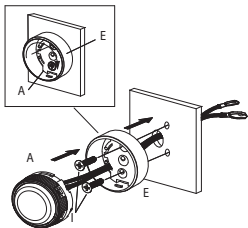

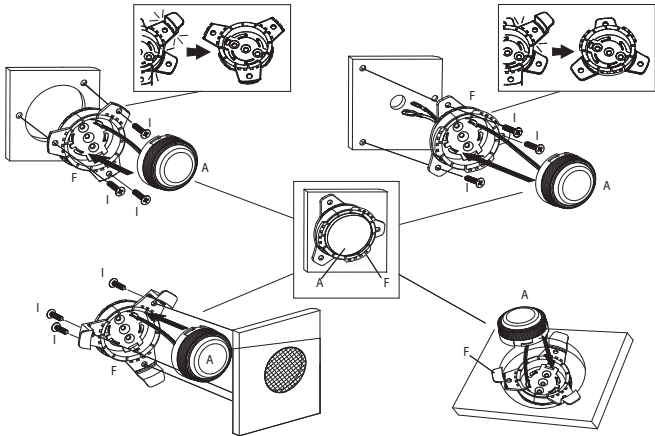

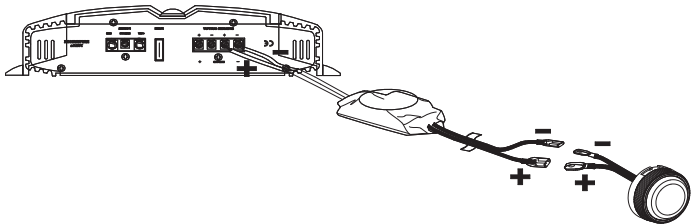

Specifikationer

- Typ: 0,75-tums (19 mm) kantdriven domediskant
- Effekt: 50 W RMS (150 W topp)
- Känslighet (vid 2,83 V/m): 93 dB
- Frekvensåtergivning: 3 kHz – 20 kHz
- Nominell impedans: 3,0 ohm

Club 64CSQ

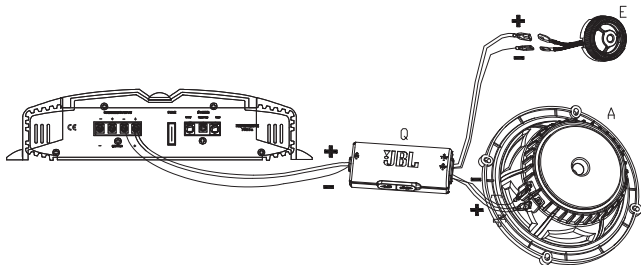
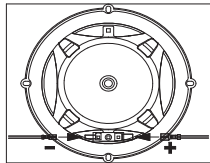

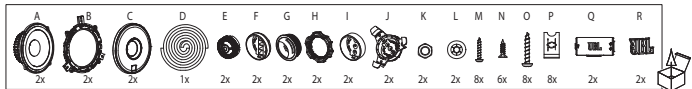
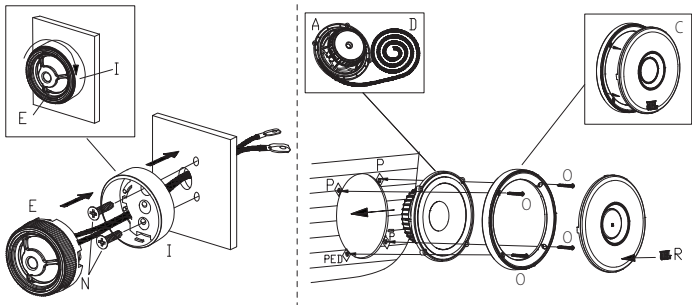

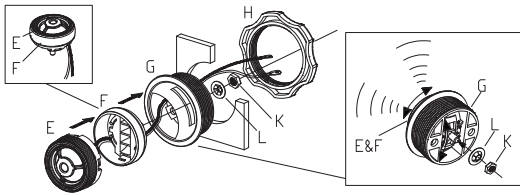
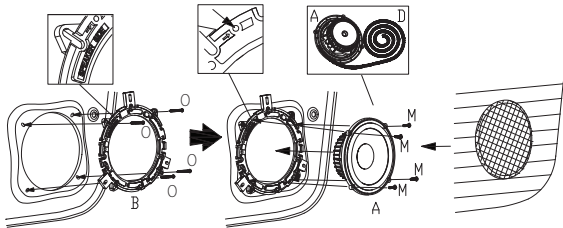

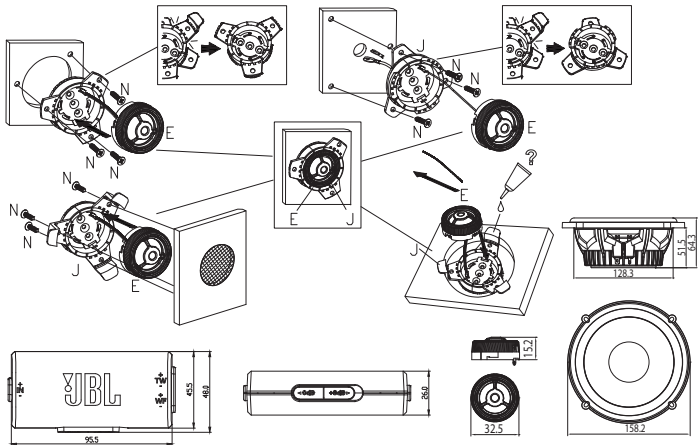

Specifikationer

- Typ: 6,5-tums (160 mm) 2-vägs komponenthögtalarsystem, konstruerat för ultimat ljudkvalitet.
- Effekt: 95 W RMS (285 W Dynamiskt)
- Känslighet (vid 2,83 V/m): 93 dB
- Frekvensåtergivning: 48 Hz – 21 kHz
- Nominell impedans: 3,0 ohm

Thiele-Små Parametrar

- BL (Tm): 3,776
- DCR (ohms): 2,09
- Mms (g): 13,238
- Sd (cm²): 132,73
- Cms (µm/N): 0,536
- Vas (l): 13,3648
- Fs (Hz): 59,7
- Qes: 0,728
- Qms: 8,315
- Qts: 0,670
- Crossover Point: 5 kHz

Club 64C

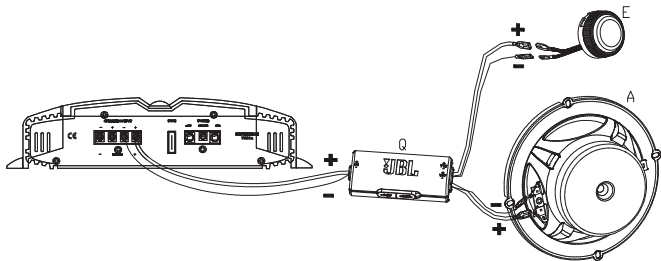
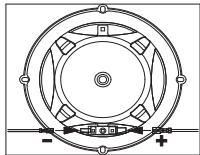

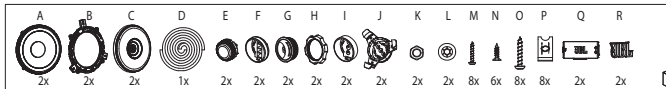
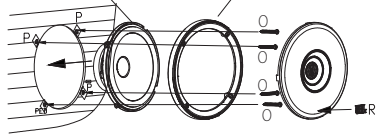
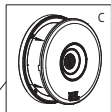
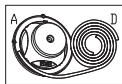
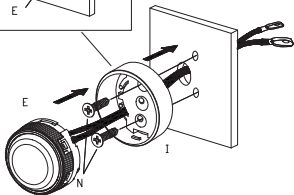
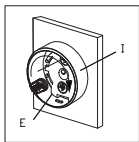

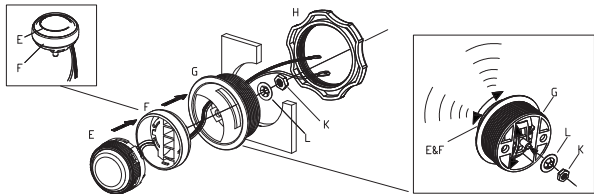
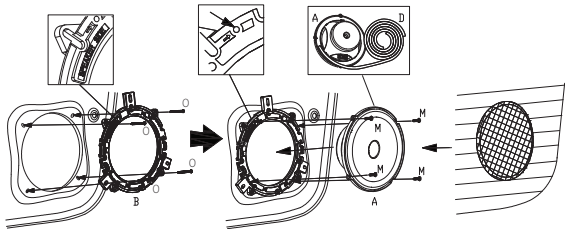

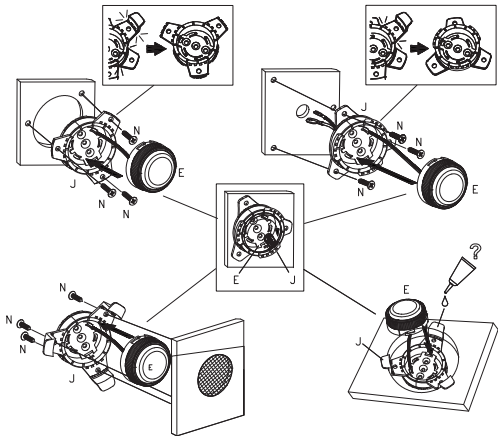

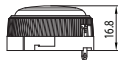
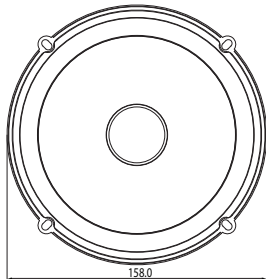
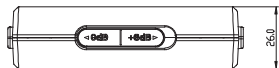
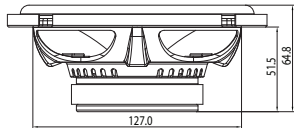
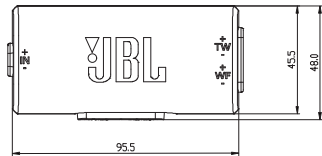

Specifikationer

- Typ: 6,5-tums (160 mm) tvåvägs komponenthögtalarsystem
- Effekt: 70 W RMS (210 W Dynamiskt)
- Känslighet (vid 2,83 V/m): 92 dB
- Frekvensåtergivning: 55 Hz – 20 kHz
- Nominell impedans: 3,0 ohm

Thiele-Små Parametrar

- BL (Tm): 3,635
- DCR (ohms): 2,37
- Mms (g): 14,409
- Sd (cm²): 132,73
- Cms (μm/N): 0,257
- Vas (l): 6,4107
- Fs (Hz): 82,7
- Qes: 1,340
- Qms: 10,965
- Qts: 1,194
- Crossover Point: 5,5kHz

Club 64CTP

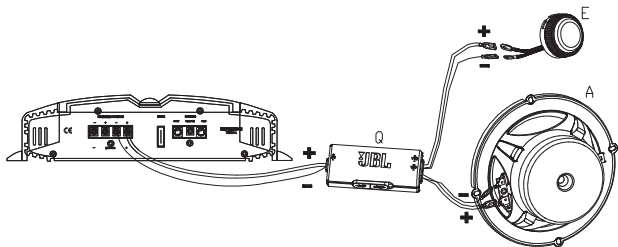
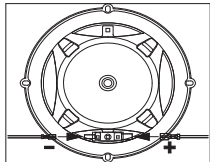

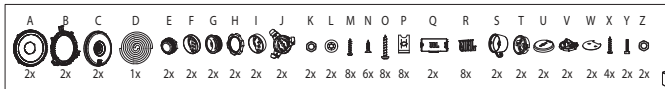
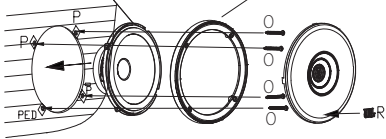
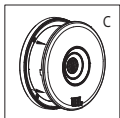
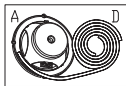
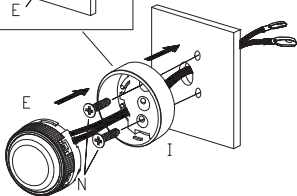
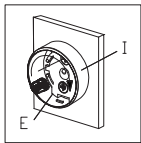

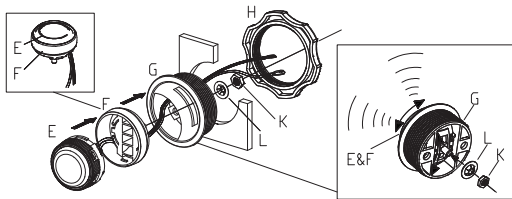
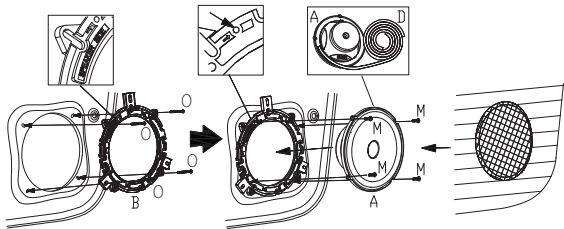

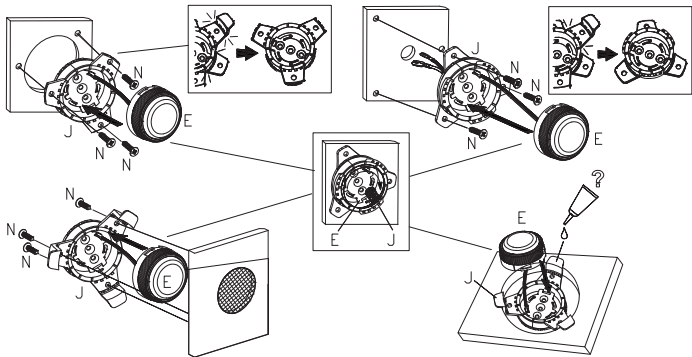

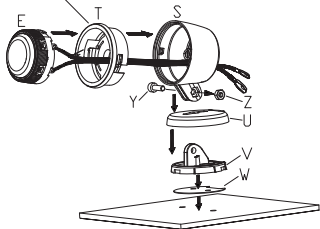
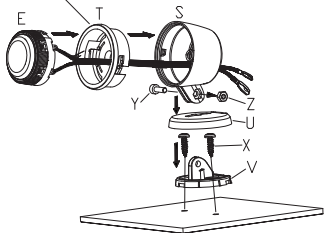

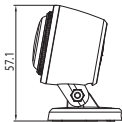
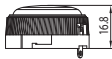
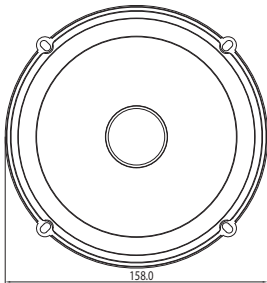
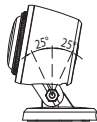
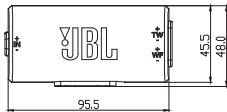
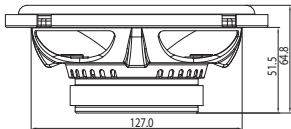

Specifikationer

- Typ: 6,5-tums (160 mm) tvåvägs komponenthögtalarsystem med diskantkapsel
- Effekt: 70 W RMS (210 W topp)
- Känslighet (vid 2,83 V/m): 92 dB
- Frekvensåtergivning: 55 Hz – 20 kHz
- Nominell impedans: 3,0 ohm

Thiele-Små Parametrar

- BL (Tm): 3,635
- DCR (ohms): 2,37
- Mms (g): 14,409
- Sd (cm²): 132,73
- Cms (μm/N): 0,257
- Vas (l): 6,4107
- Fs (Hz): 82,7
- Qes: 1,340
- Qms: 10,965
- Qts: 1,194
- Crossover Point: 5,5kHz



HARMAN International
Industries, Incorporated
8500 Balboa Boulevard,
Northridge, CA 91329 USA

© 2023 HARMAN International
Industries, Incorporated

Med ensamrätt. JBL är ett varumärke som tillhör HARMAN International Industries, Incorporated, registrerat i USA och/eller andra länder.

Funktioner, specifikationer och utseende kan komma att ändras utan att detta meddelas.